

VINDICATOR

CHANCE VOUGHT

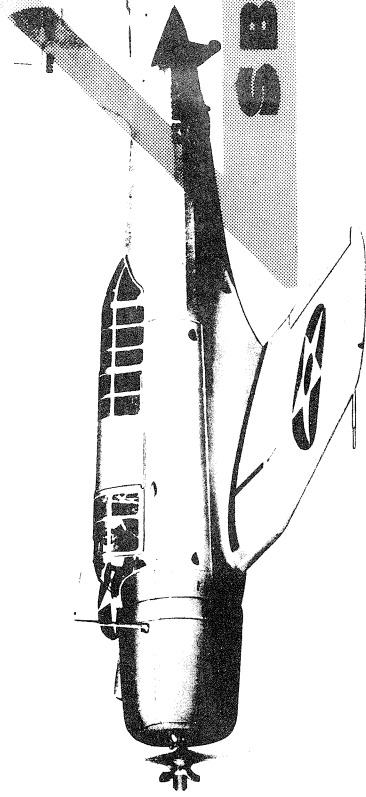

SB2U-1

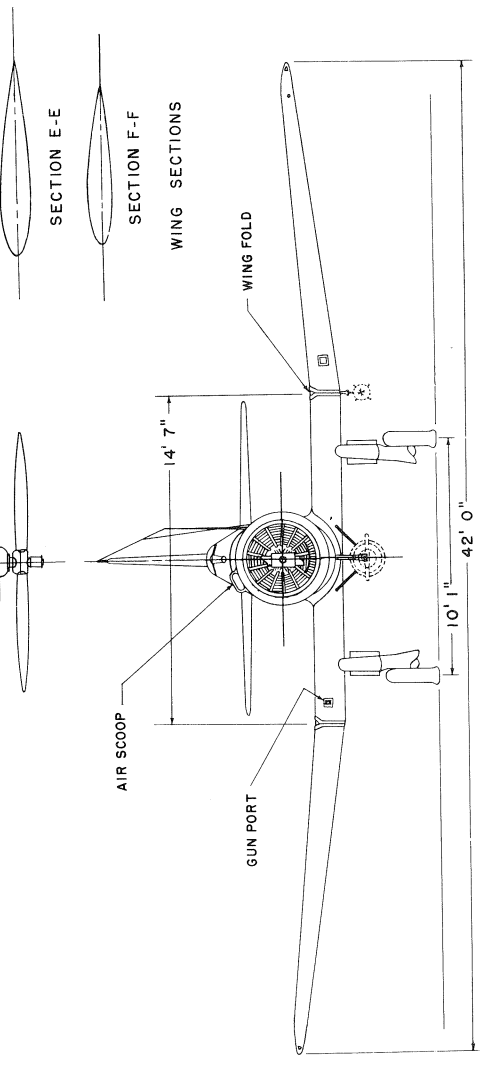
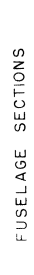
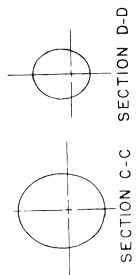
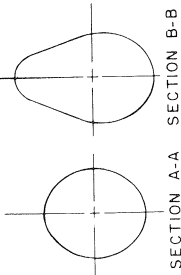
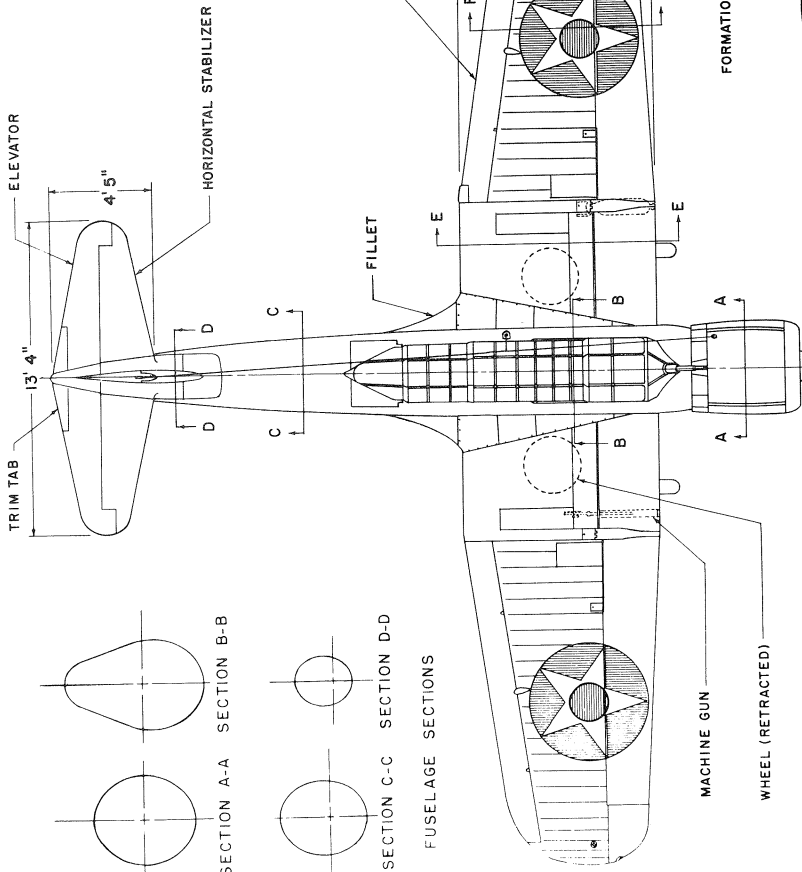

U. S. NAVY
SB2U-1 "VINDICATOR"
 BUILT BY
CHANCE VOUGHT AIRCRAFT
 DIVISION OF
UNITED AIRCRAFT CORPORATION
 DALLAS, TEXAS

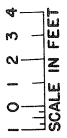

The SB2U-1 Vindicator, a scout bomber produced for the U. S. Navy by Chance Vought Aircraft in 1937, was the first monoplane manufactured by the company.

Wing Span	42'	Height	9' 10"
Length	34'	Power Plant	Pratt & Whitney "Twin Wasp, Jr.," R-1535-46

