

SCALE
THREE FEET

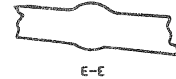

E-E
SECTION THRU WING
AND ENGINE NACELLE

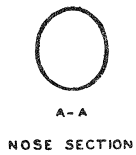
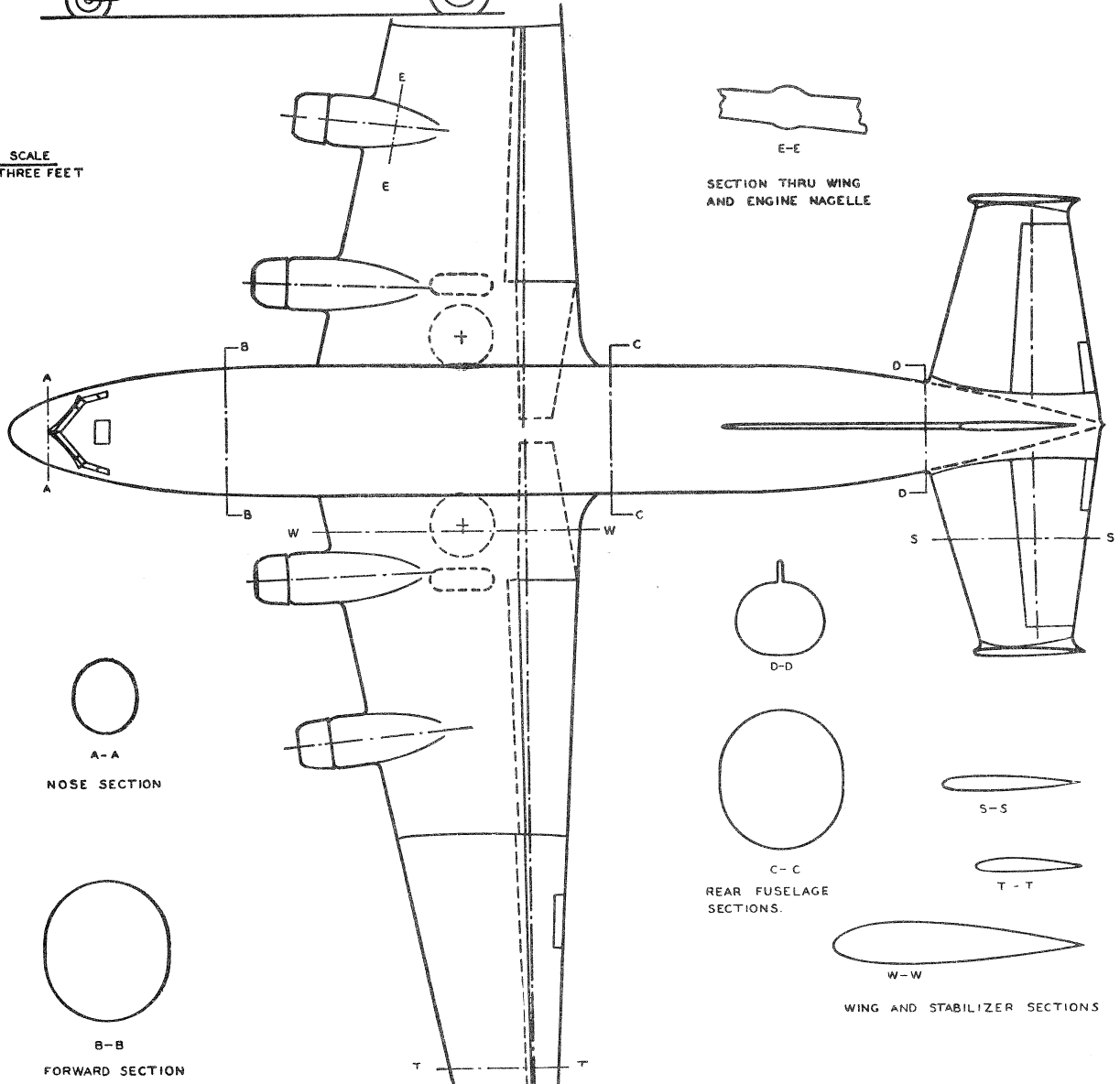

A-A
NOSE SECTION

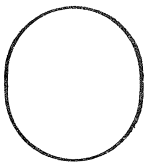

B-B
FORWARD SECTION



D-D

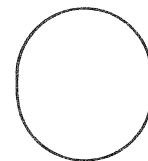

C-C
REAR FUSELAGE
SECTIONS.

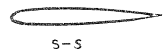

S-S

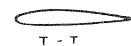

T-T

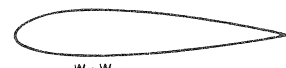

W-W

WING AND STABILIZER SECTIONS

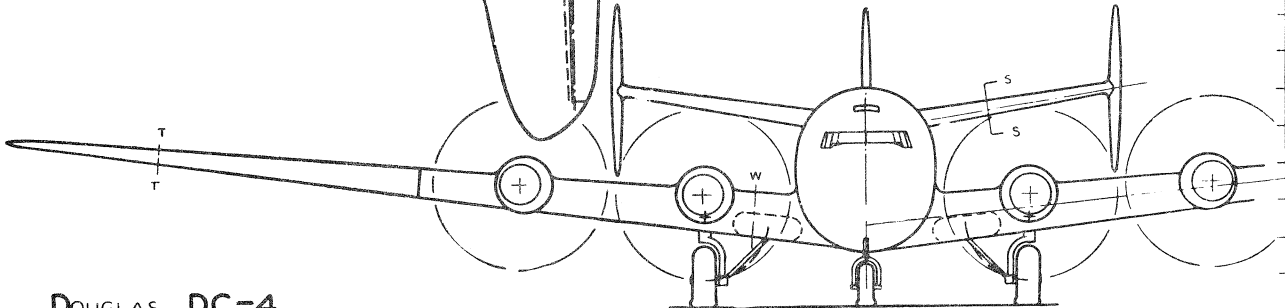

DOUGLAS DC-4
HARRY S. PACK, JR.