

FULL-SIZE PLANS FOR THE MARTIN "MARS" - PLATE 1

MARTIN MARS
U.S. NAVY'S LARGEST PATROL BOMBER
PLATE - 1 DRAWN BY - CARL BINDER

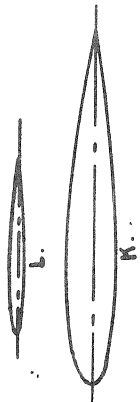

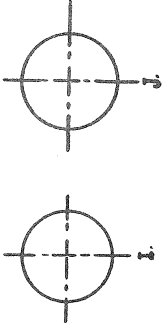
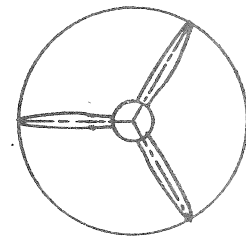
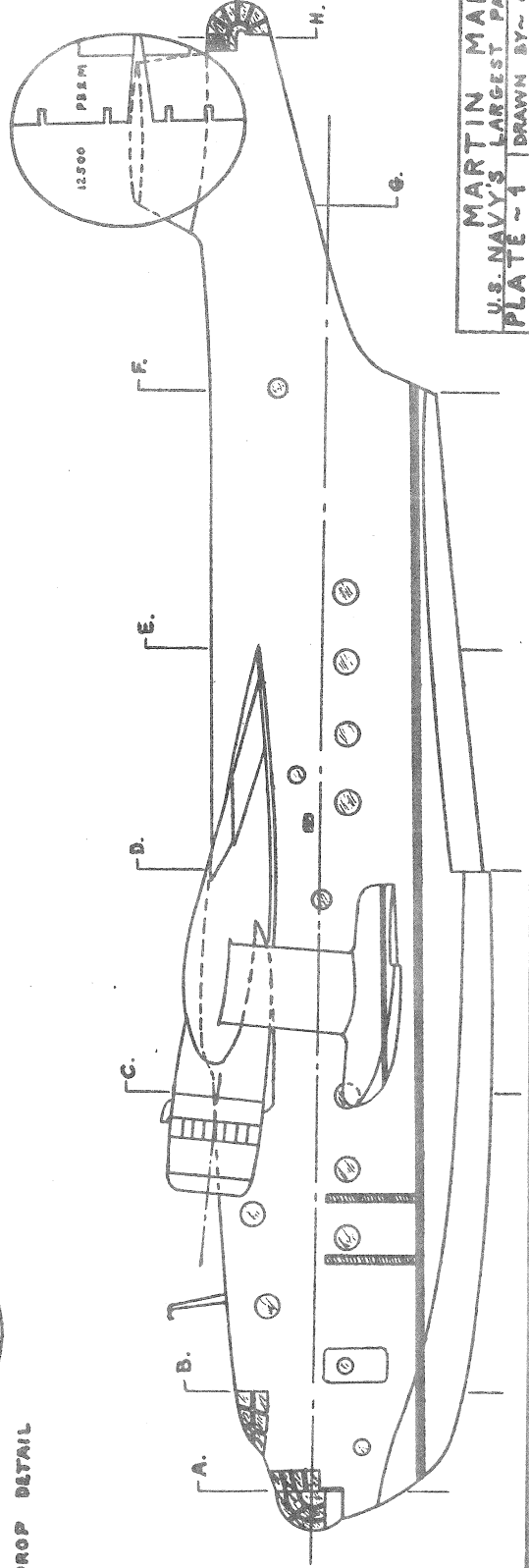
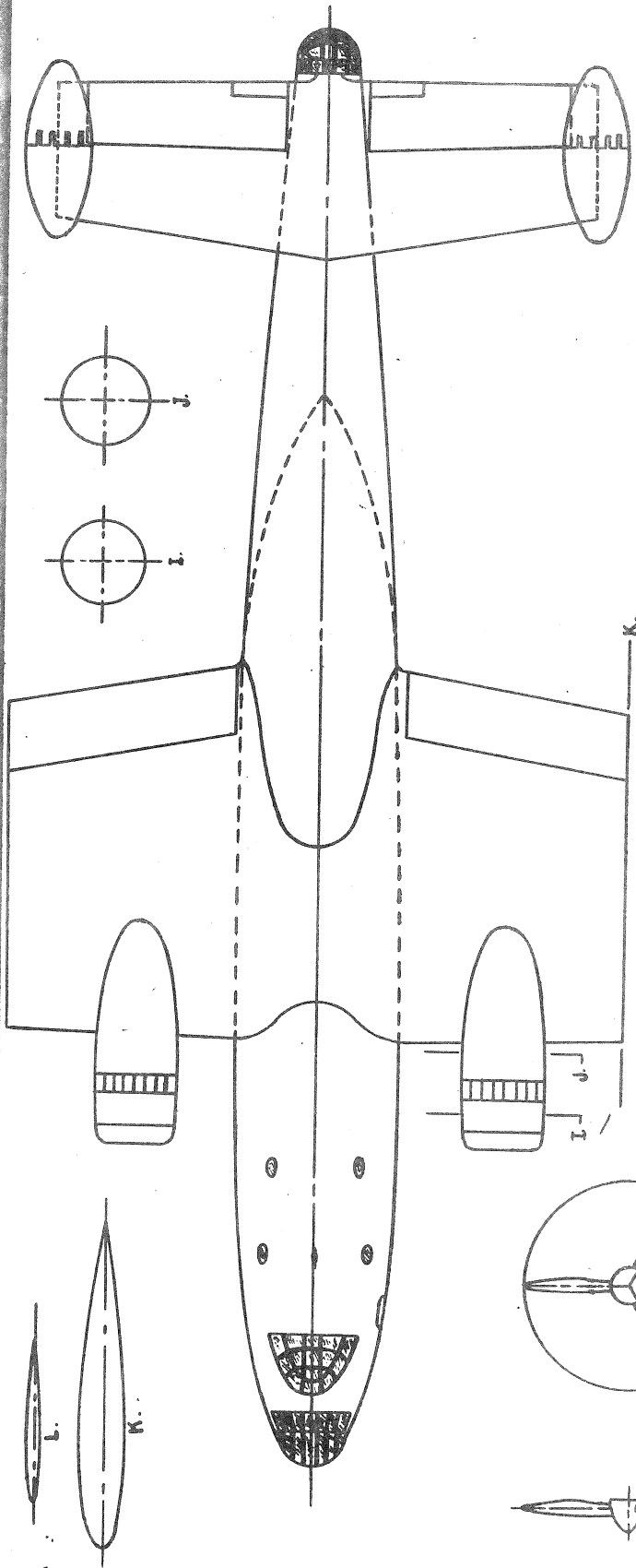
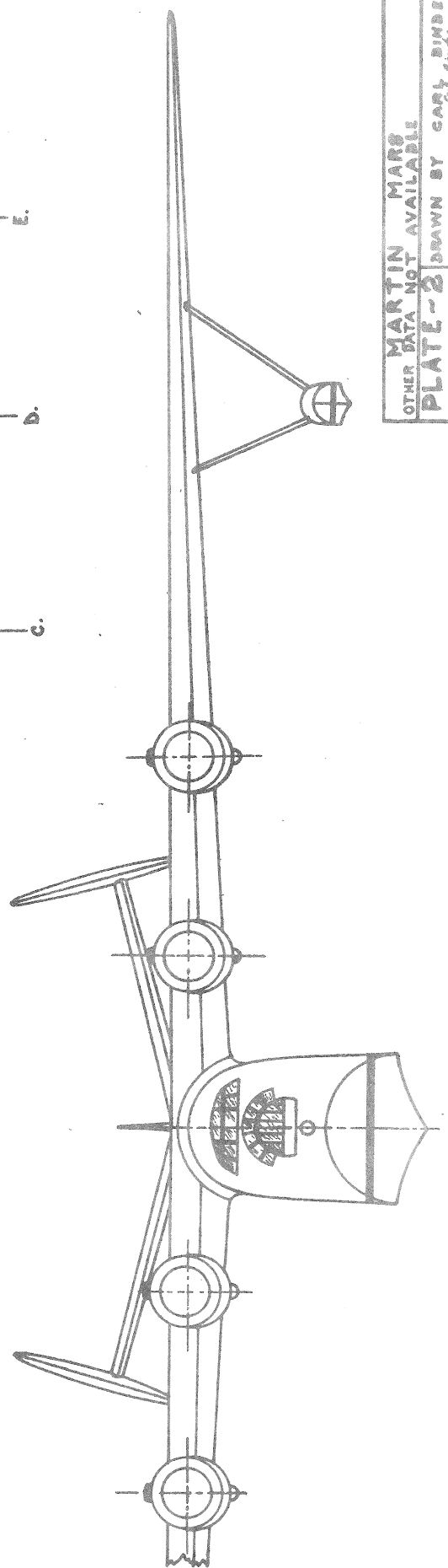
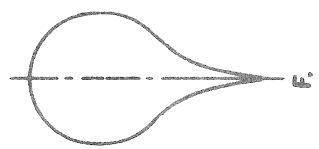
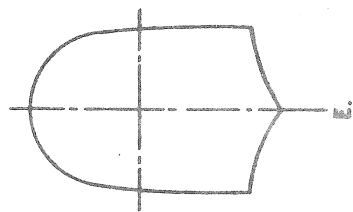
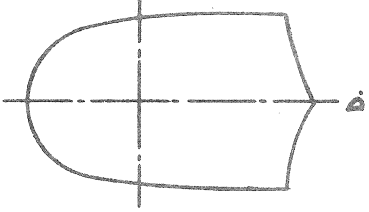
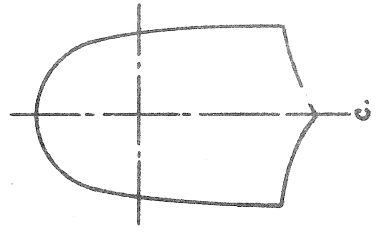
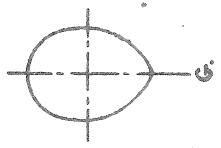
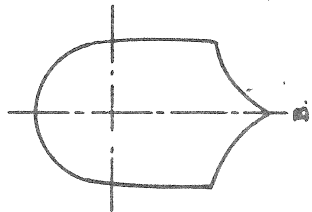
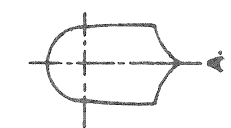
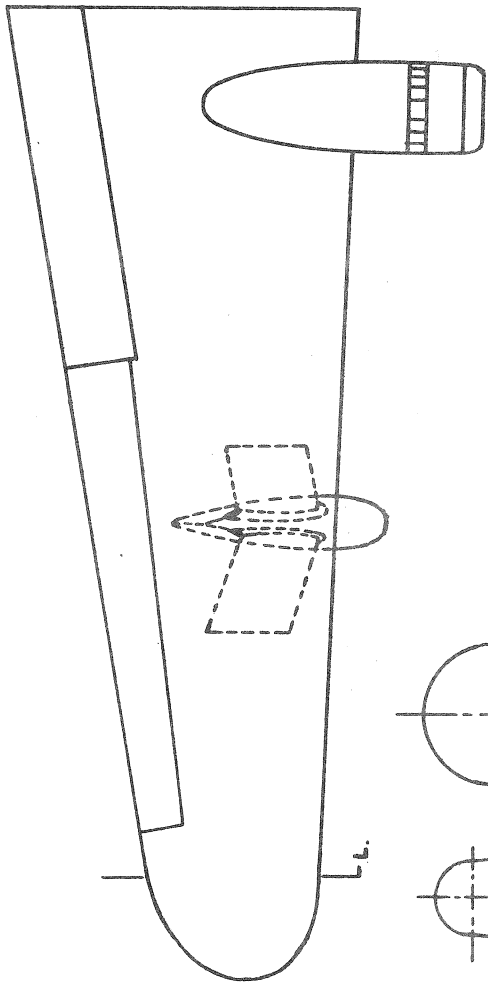

MARTIN MARS
OTHER DATA NOT AVAILABLE
PLATE-2 DRAWN BY CARL BINDER