

30.3

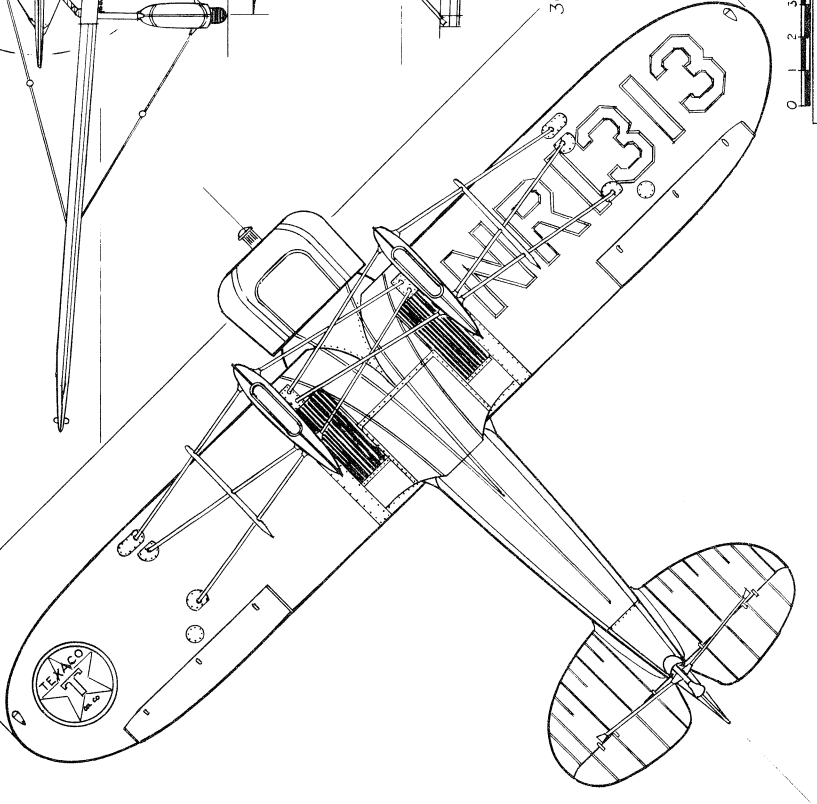

1930-31

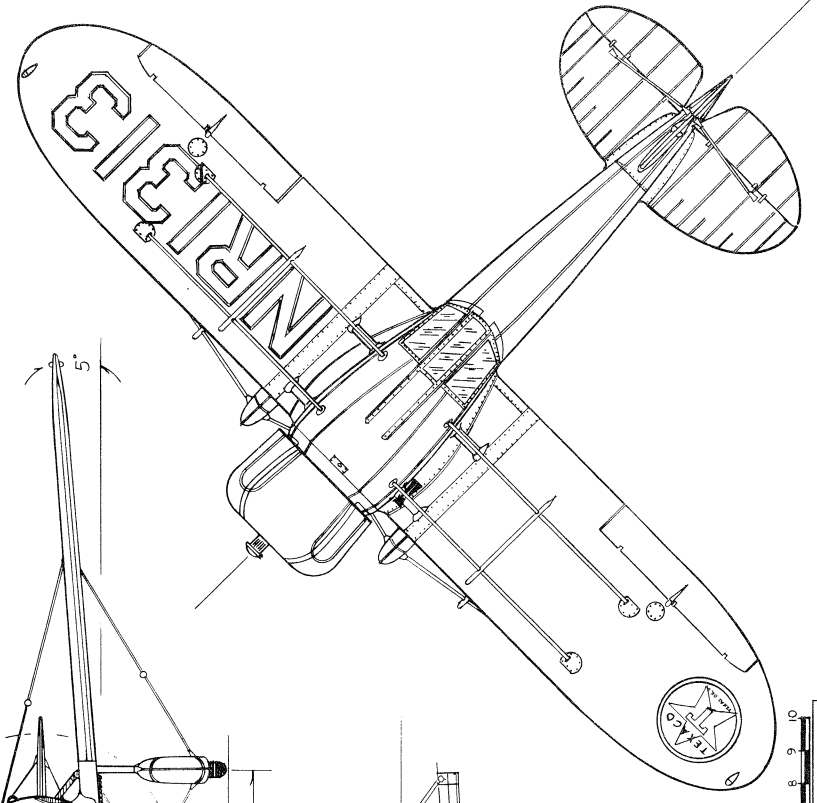

© 1965  
**TRAVEL AIR**  
 MODEL "R"  
 FRANK HAWK'S SHEET 4

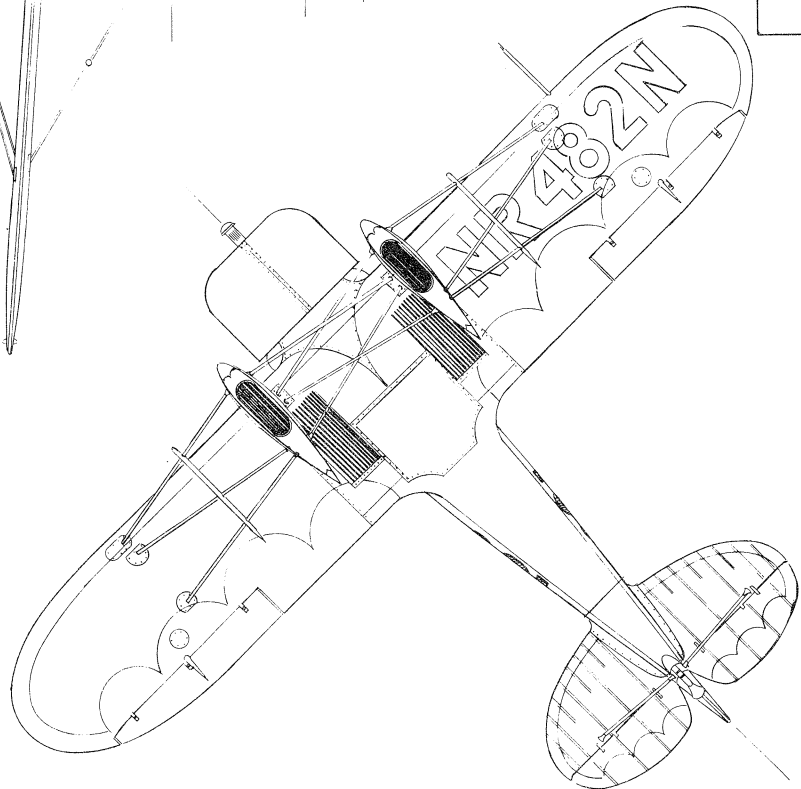
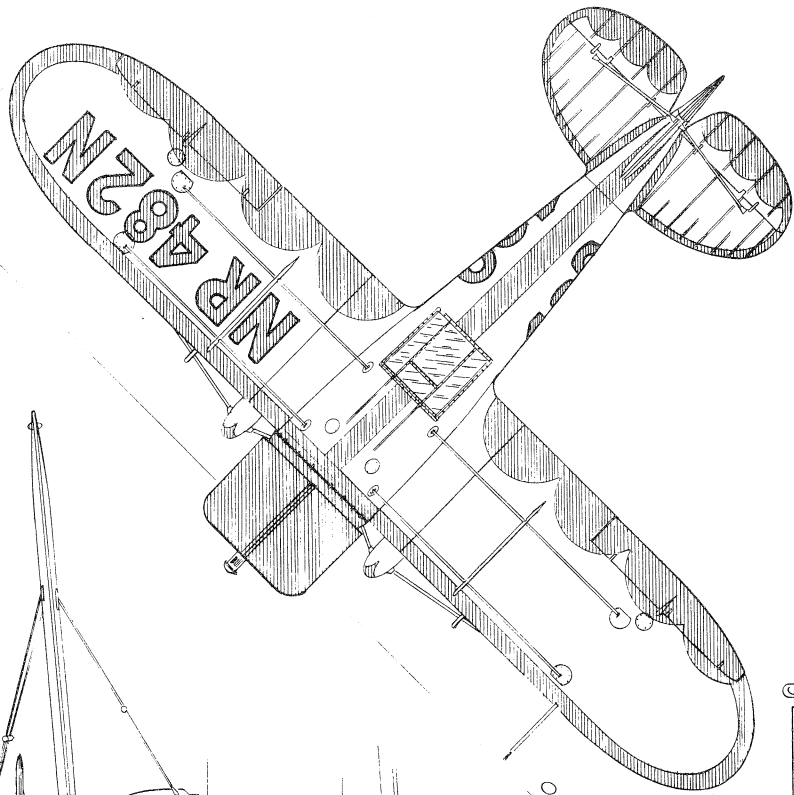
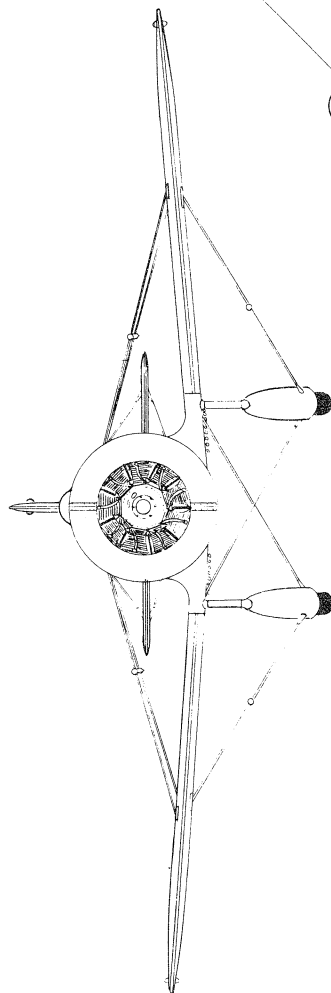
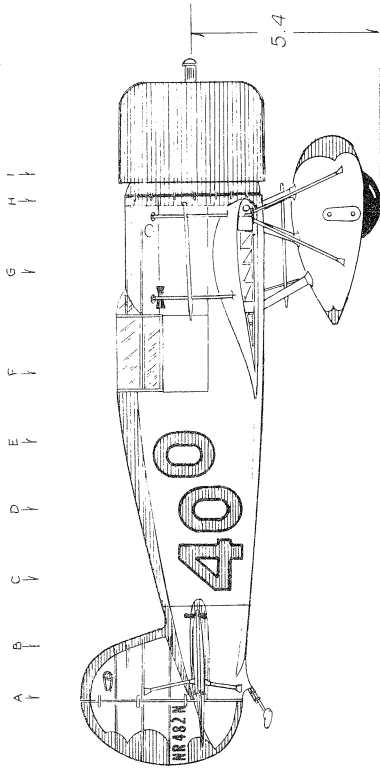
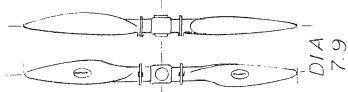
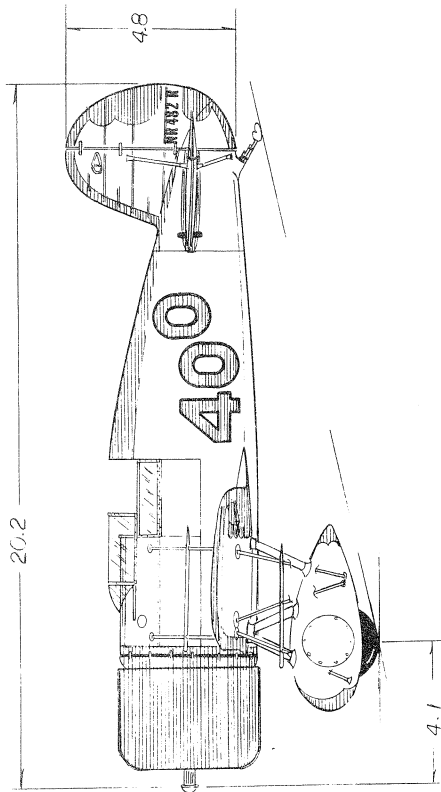

1931

© 1967  
P.S. HIRSCH  
TRAVEL AIR  
MODEL R  
SHELL OIL CO. SHEET 5